

Essential Kit
for Plumbers!

Aladdin
Products



Aladdin EasyFit Isolator 22mm & 3/4" (UK): The Quick-fit Plumbing Isolation Valve for Pressurised Pipe

The Aladdin EasyFit Isolator clamps directly onto live pressurised pipe (hot or cold), safely providing a full bore, permanent stopcock, no need to restrict services or freeze pipes.

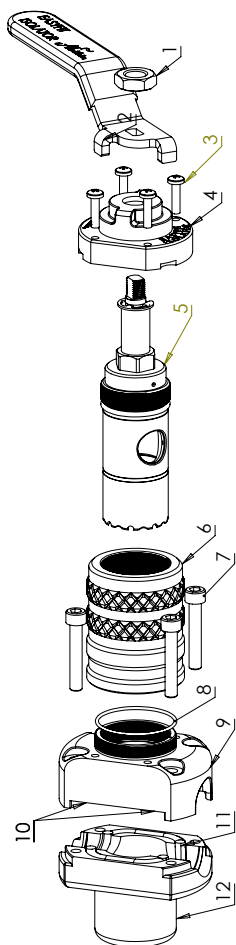

22mm & 3/4" (UK) Aladdin EasyFit Isolator		
Item No.	Descriptions & Materials (WRAS Approved EPDM Seals)	No. Units
1	M10 x 1.5 Hex Half Nut (Stainless Steel)	1
2	Red and Blue Handle	2
3	M4 x 16 Thread Forming Screws (22mm Model)	4
4	Polyacetal Plastic Cap	1
5	Plug Assembly - High Tensile Brass Plug CZ114, Nitrile Boot EPDM Shore 70, O-ring 10mm id x 3cs Nitrile Shore 70, O-ring 30mm id x 2cs Nitrile Shore 70, Chrome Plated CZ114 Spindle, Polytube, Stainless Steel Circlip, D3 Tool Steel Blade	1
6	Collar - Aluminium 2011 Disposable Collar	1
7	M6 x 40mm high tensile (12.9) Socket Cap Screws	4
8	O-ring 37mm id x 1.5 Nitrile Shore 70	1
9	Upper Housing 304 Stainless Steel	1
10	Half O-Ring Gaskets EPDM Shore 70	2
11	Lower Gasket EPDM Shore 70	1
12	Lower Housing 304 Stainless Steel	1
13	Tool Kit - Tool Steel Long Socket, Tool Steel Hex Socket Driver Bit, Tool Steel Pozi Driver Bit	1

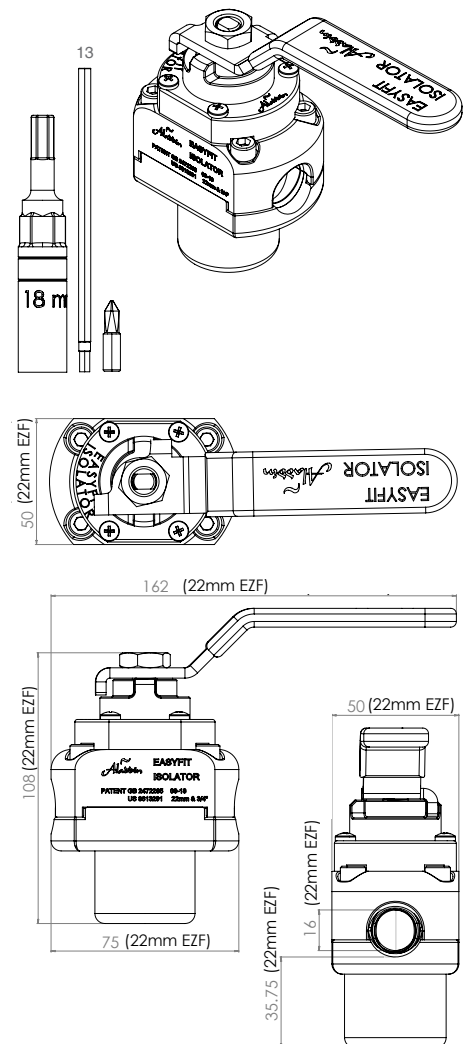

Aladdin EasyFit Isolator

22mm & 3/4" (UK): Pipe Specification



22mm EasyFit are also suitable for BS695 Imperial pipe

Aladdin EasyFit Isolator Specification	Copper BS2871 - EN1057	Copper BS2871 - EN1057	Plastic BS 7291
22mm & 3/4" (Range 21.5mm - 22.2mm) Aladdin EasyFit Isolator WRAS Approved - On Sale Now!			
	0.9 wall thickness	1.2 wall thickness	
Max Operating Pressure	16 bar	16 bar	6 bar
Max Operating Temperature	85 deg. C	85 deg. C	82 deg. C
Manufacturers Warranty	10 yr	10 yr	5 yr
Pipe Size	22mm & 3/4"	22mm	22mm
Pipe Cutting Force	30Nm	38Nm	20Nm
Max Static Pressure Installs at	16 bar	16 bar	10 bar
Max Dynamic Pressure Installs at	3 bar at 40 lit/min	3 bar at 40 lit/min	3 bar at 40 lit/min

EasyFit Isolator - Quick Guide

Read full instructions before installing (Enclosed with purchase)

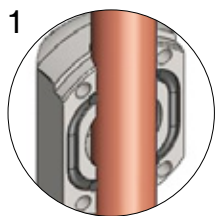

1 Rotate Lower Housing onto pipe

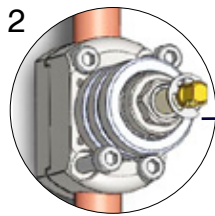

2 Clamp Housing using x 4 Bolts

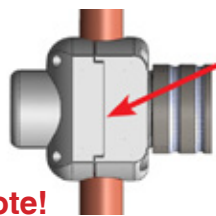

Note!
Hosing halves must be completely flush on both sides. The gasket may extend from the gap.

Installation Video

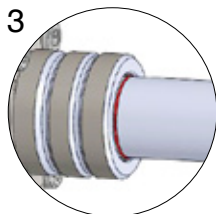

3 With Socket on Drill in low gear, drive down to the red Reference Line

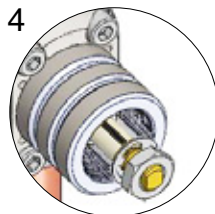

4 Remove Collar

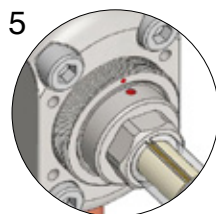

5 Align Red Dots

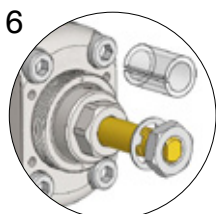

6 Remove Polytube (NOT CIRCLIP)

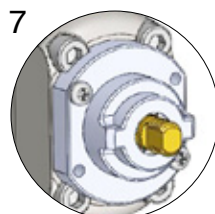

7 Fit Plastic Cap & Handle

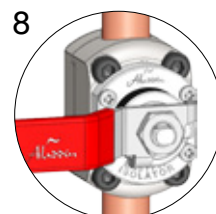

8 Isolated!

SINGLE USE ONLY

MUST BE installed using the re-usable Aladdin Tool Kit

Aladdin EasyFit Isolator 22mm & 3/4" (UK)

Product Code:

EZF06 Starter Pack includes Tool Kit
EZF04 Refill Pack
EZF05 Tool Kit

Aladdin EasyFit Isolator Approvals:

WRAS 2001357
KIWA 2001725

Aladdin EasyFit Isolator Product Dimensions:

108mm(H), 75mm(L), 50mm(D), 1.23Kg

Packaging Dimensions and Weight:

EZF06: 220mm(H), 220mm(L), 55mm (D), 1.460Kg
EZF04: 220mm(H), 220mm(L), 55mm (D), 1.250Kg
EZF05: 150mm(H), 30mm (L), 30mm (D), 0.235Kg

Packaging Materials:

Cardboard Carton, Foam Insert,
Full Colour Folded Paper Instructions.

Essential Kit for Plumbers!

